

DRAWING NO.	MATERIAL:	ORIGIN:
S-802-4	LCP E4008	DG

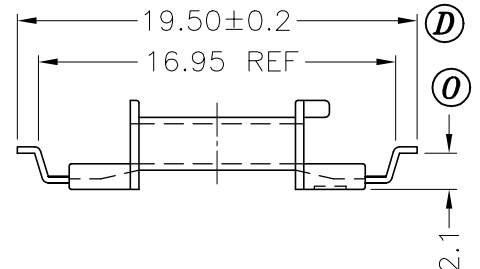

DRAWING NO.	MATERIAL:	ORIGIN:
S-802-3	LCP E4008	DG

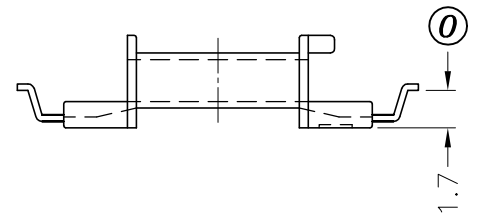

DRAWING NO.	MATERIAL:	ORIGIN:
S-802-2	LCP E4008	DG

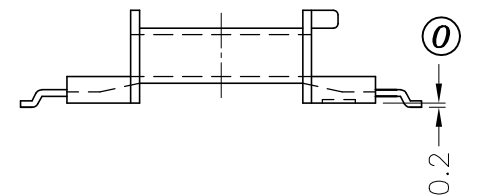

DRAWING NO.	MATERIAL:	ORIGIN:
S-802-1	LCP E4008	DG

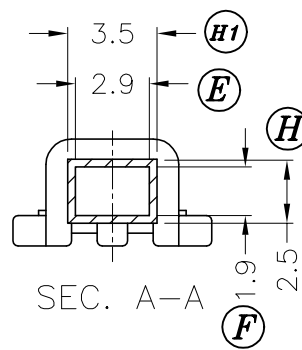
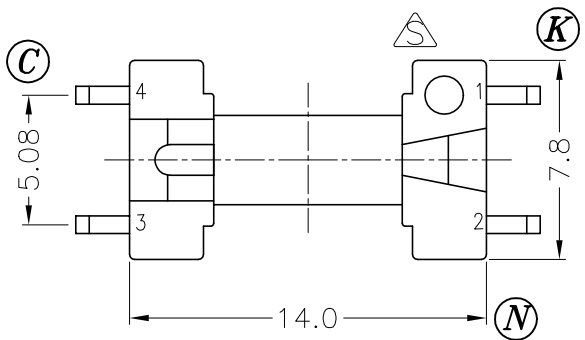
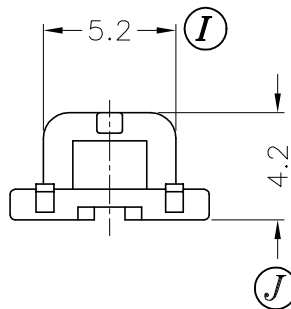
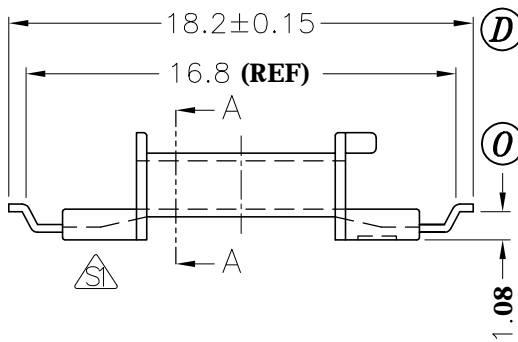
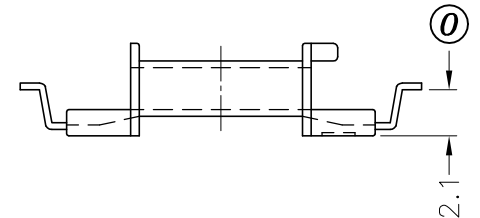

REV.	REVISIONS	REC.	REV.	REVISIONS	REC.
1	△:ADD A CAV AND SHAPE MODIFIED				
2	CANCEL (O); UPDATE DRAWING				

DRAWN & DRAFTED BY	TSUNG TUAN	TOLERANCES		ANGLE:	TITLE:	
		0<L≤4 ±0.1	COPLANARITY	±1°	SMD BOBBIN ED-8.0	
CHECKED & APPROVED BY	CHIN TE	4<L≤16 ±0.2	0.1 MAX	UNIT:	BOBBIN MATERIAL:	UL REC.
		16<L≤63 ±0.3		MM	LCP E4008	UL 94V-0
				ORIGIN:	PIN MATERIAL:	PIN TENSION LOAD:
				DG	PHOSPHOR BRONZE	1.5KG MIN.
					DATE:	DRAWING NO.
					APR.02 '2003	S-802
						REV.
						2



PIN SHINE INDUSTRIAL CO., LTD.

TEL:886-2-22990545

FAX:886-2-22990546

